

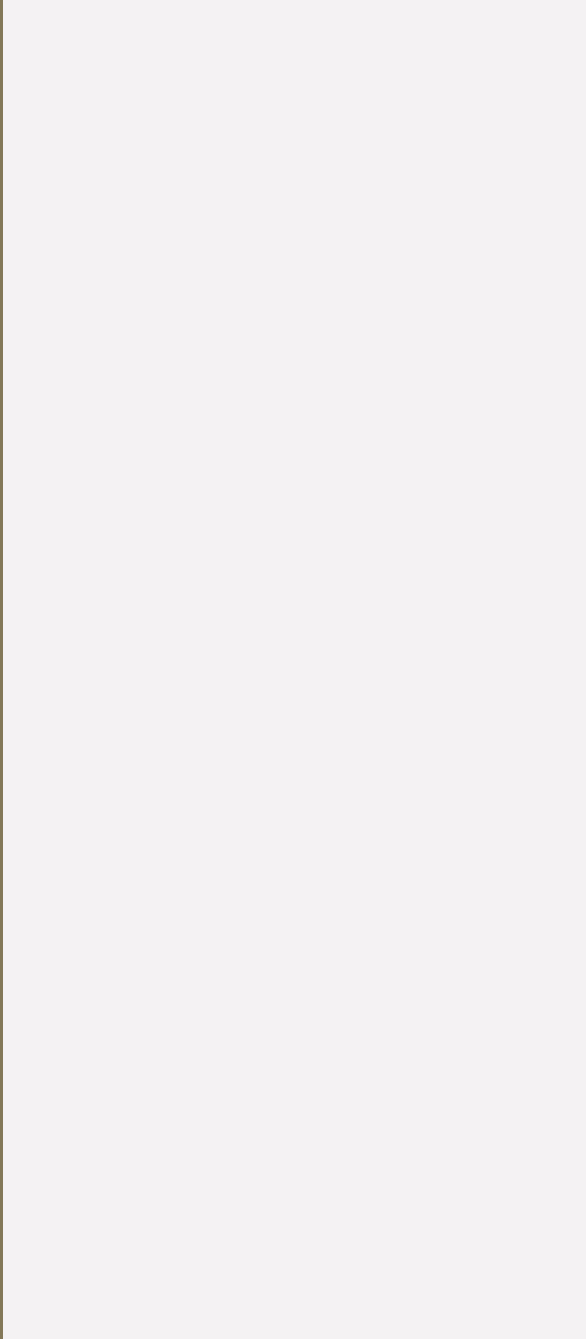

THE
REUSE
COMPANY

SES ENGINEERING Studio: Digitalizing the System Life Cycle Management Processes

by Integrating the Tools of your Ecosystem and their
corresponding Information and Functionalities





SES ENGINEERING Studio: Digitalizing the System Life Cycle Management Processes

by Integrating Tools of your Ecosystem and their corresponding information and functionalities.

Improving the digitalization of the system life cycle management.

Dear reader,

As you might know, The REUSE Company (TRC) is a tool vendor specialized in the application of semantic technologies and reuse concepts to improve the digitalization of the system life cycle management. After a lot of hard work, we are now ready to present our

expanded product portfolio, and with this brochure we want you to dig into our approach.

In our vision, system life cycle management methodologies must be guided by reuse, driven by a knowledge-centric and model-based approach, must support the concept of Authoritative Source of Truth (ASoT), and shall be capable to integrate Document legacy approaches inside the modern MBSE (Model Based Systems Engineering) paradigms.

Message From The CTO



A handwritten signature in black ink, consisting of several overlapping loops and lines, representing the name Juan Llorens.

Juan Llorens
CTO - The REUSE Company

How do we support this vision?

In order to digitalize System Life Cycle Management Processes, we state an Interoperability HUB platform (named SES ENGINEERING Studio) providing connectivity to all existing siloed tools within your current ecosystem of tools, enabling unlimited interoperability among the connected tools, and offering support to the technical management processes (as defined in ISO 15288) for the entities and work-products managed by these tools.

Even more, The REUSE Company sets a specific focus on transforming Microsoft Office tools into complete Systems Engineering authoring solutions, thus getting the best of both worlds, the flexibility and simplicity of this Office platform, with the discipline required by any engineering process.

If you're interested in this approach, please, carry on reading or contact us to get personalized information.

SES ENGINEERING STUDIO (SES)



SES manages the system life cycle by integrating and interoperating the information provided by whichever tool.

The SES ENGINEERING Studio proposal covers the entire system life cycle by integrating and interoperating the information provided by the different tools used during the system's concept, development, production, acquisition, utilization, support, or retirement life cycle stages.

By becoming the Interoperability HUB, SES can provide full technical management support (Configuration management, Traceability, Conflict management, Quality management, Information management, Knowledge management, etc.) to a wide list of connectable tools, thus allowing smart interoperability among them and providing complete support along the system's life cycle.

SES becomes an Interoperability HUB & offers a complete Repository

As an Interoperability HUB, SES implements and offers a complete Repository, where the information from the siloed tools is synchronized and maintained, building a pure authoritative source of truth. We have coined the name "Synchronized Source of Truth" (SSoT) to refer to this concept.

The core of the repository is an Ontology, known as the System Knowledge Base, allowing SES to provide smart systems engineering capabilities, such as automatic detection of consistency

problems, automatic verification processes, automatic discovery of missing traces, automatic generation of logical models, requirements, parts models, etc.

Finally, SES (in its version V23.2 and above) allows the explicit definition of Life cycle templates to manage and monitor the progress of complex projects by defining workflows supporting the different technical processes, their inputs and outputs, and the corresponding engineering tools of your ecosystem.

The combination of the following capabilities provides a powerful system life cycle management solution with a strong REUSE approach: interoperability among them, technical management digitalization for whatever different external tools, connection, ontologies, a repository for defining sources of truth, and the possibility of defining the life cycle model.

The Concept of System Life Cycle Management (SysLCM)

In The REUSE Company's approach, every piece of data, information, and knowledge gathered (and used) during the different stages of the life cycle of a system (product or service) must be integrated and made available to every concerned stakeholder, when it is needed, and through the corresponding authenticated channels.

We, therefore, understand the already existing concept of System Life cycle Management as one completer and more interwoven than the classical PLM (Product Life Cycle Management) approach (this one perhaps more focused on digitalizing the management of physical parts and their corresponding digital artifacts). In the SysLCM approach, all the engineering items produced at any technical process during the development of a system, as well as the information coming from PDM, ERP, MES, SLM, etc., must be conceptually linked under a holistic, consistent, and integrated manner.



In this view, the hardest aspect to solve is finding an accurate integration of all the authoring tools (the current silos, maintaining the individual sources of truth) and all the different information models. SES intends to solve this problem.

We understand the concept of System Life cycle Management as one more complete and more interwoven than the classical PLM approach.

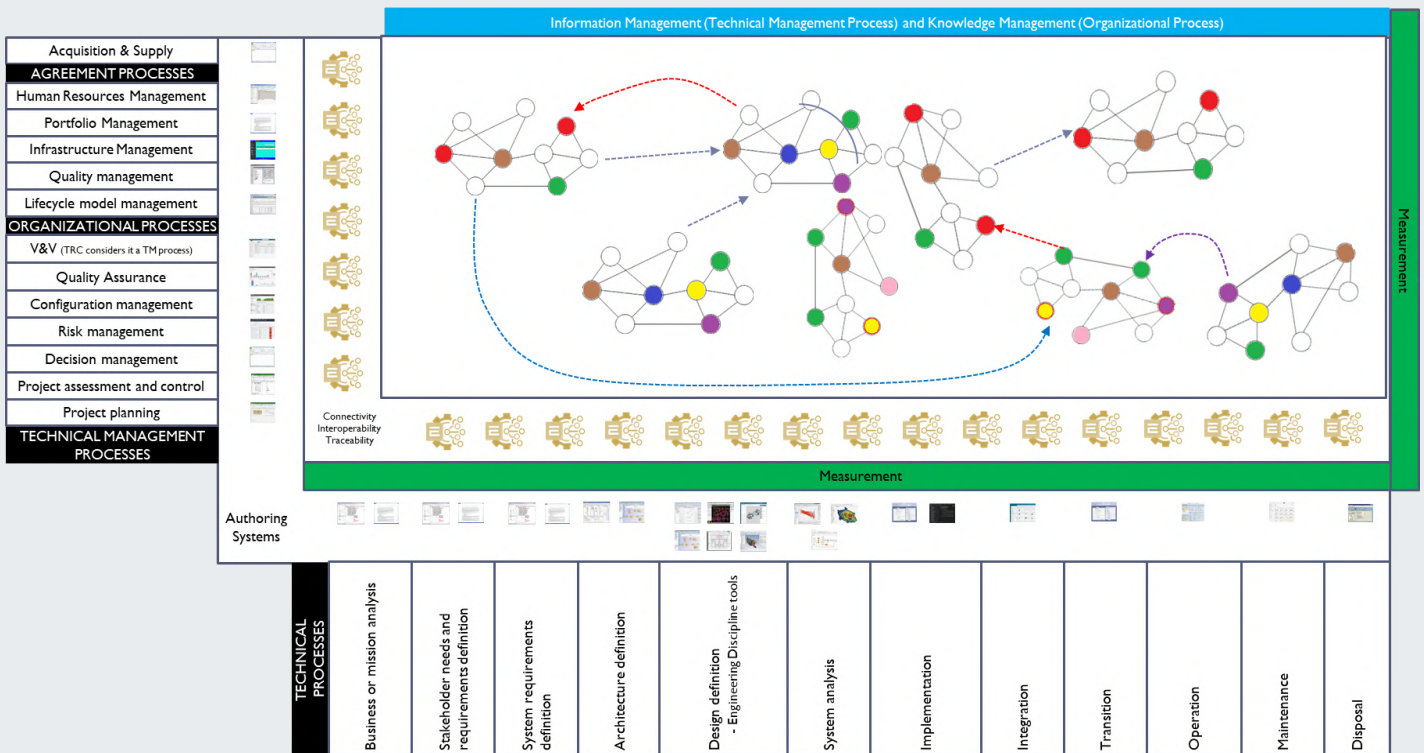

System Information Connectivity: The Interoperability HUB

SES provides an efficient and innovative alternative to enable the Digital Thread.

In the current Systems Engineering domain, the complexity of the processes and the amount of tasks to be managed has pushed the need for a wide spectrum of different tools within a project, an organization or even within different organizations (remote tools connection), each one specifically designed to cover a niche of the entire system life cycle. While being the most efficient approach to precisely handle each engineering process with its specialized tool, collecting and integrating every piece of information into a global project perspective can pose a huge challenge, as well as an opportunity.

Before the existence of SES, systems engineers had two potential options to somehow enable the *Digital Thread*. With SES, a third option has appeared:





Option 1

Manual Connection of Siloed Tools

Completing each specific task within the consequent tool or environment and **manually** exporting and importing every piece of desired information (status, reports, modifications, etc.) from process to process (tool to tool), if allowed by both, source and target. Due to the complexity and the extensive number of iterations required in most projects, this approach can easily become extremely tedious and repetitive for engineers and can put the overall project development in danger.



Option 2

A single tool vendor

Work exclusively with one single tool vendor and rely on the completeness and maturity of the proposed solutions for all the processes. This unique provider oversees providing as much integration and interoperability as possible among the offered tools. Despite the attractiveness of this potential solution, several problems arise: one single provider does not always have the best tools for all the processes, and most of the time some tools are very well fitted to the customer's culture while others are not. Besides, most engineering companies have been working with certain tools for many, many years, and transitioning can suppose a frightening step for them.



Option 3

SES ENGINEERING Studio

We, as systems engineers, must aim at the maximum benefit of the complete ecosystems of tools, holistically, and not just maximize the performance of individual tools. Therefore, here is where the **third and most innovative option** comes into play, under the name of **SES ENGINEERING Studio**.

SES ENGINEERING Studio has been designed to connect the existing siloed tools: Requirements Management (RMS), Logical Modelling tools, System Analysis tools, Physical, mechanical, electrical, 3D modeling tools, Product Life cycle Management (PLMs), CAD, CAE, CAM, FMEA, ERPs, Microsoft Office, and many more.

Currently, the SES environment is capable of handling:

Textual Sources

IBM DOORS, DNG, MS Excel, MS Word, PTC Windchill, Siemens Polarion, Siemens Teamcenter, PDF, etc.

Logical Modeling

Cameo Systems Modeler, Capella, Enterprise Architect, MS PowerPoint, Siemens Teamcenter, etc.

System Analysis

Open Modelica, Simulink, FMU, DLL, etc.

Physical Modeling

DS Solidworks, PTC Creo, MS Visio, etc.

Functional Behavior Sources

FMU Connectors, MS Excel Functions, Dynamic Linked Libraries, etc.

PLMs

PTC Windchill, Siemens Teamcenter, etc.

Others

DBMS, JIRA, Pure Variants, XML, Custom Connections, etc.

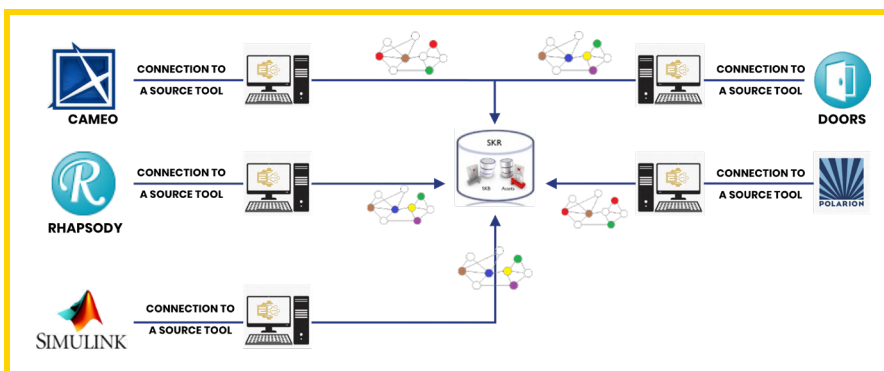

This list of connections continues expanding day after day, by combining the experience gathered in the creation of those, with the needs and requests of our users. Some of these connections are even upgraded to the level of **integration**, where a subset of capabilities offered by the **SES ENGINEERING Studio** is embedded directly into the source information tool.

The Synchronized Source of Truth (SSoT) paradigm

SES has coined the name **“Synchronized Source of Truth” (SSoT)**.

Once the tools are connected, by using the information representation model designed by The REUSE Company, it becomes possible to implement the “Authoritative Source of Truth” (ASoT) concept. To implement the ASoT, SES has coined the name “Synchronized Source of Truth” (SSoT).

In the SSoT implementation, the Source of Truth remains always at the dedicated tool (DOORS, Cameo, etc.) and SES is in charge of synchronizing the information from all the tools in a single and authoritative repository, unifying it. Every time SES connects to the siloed tool, the information is synchronized.

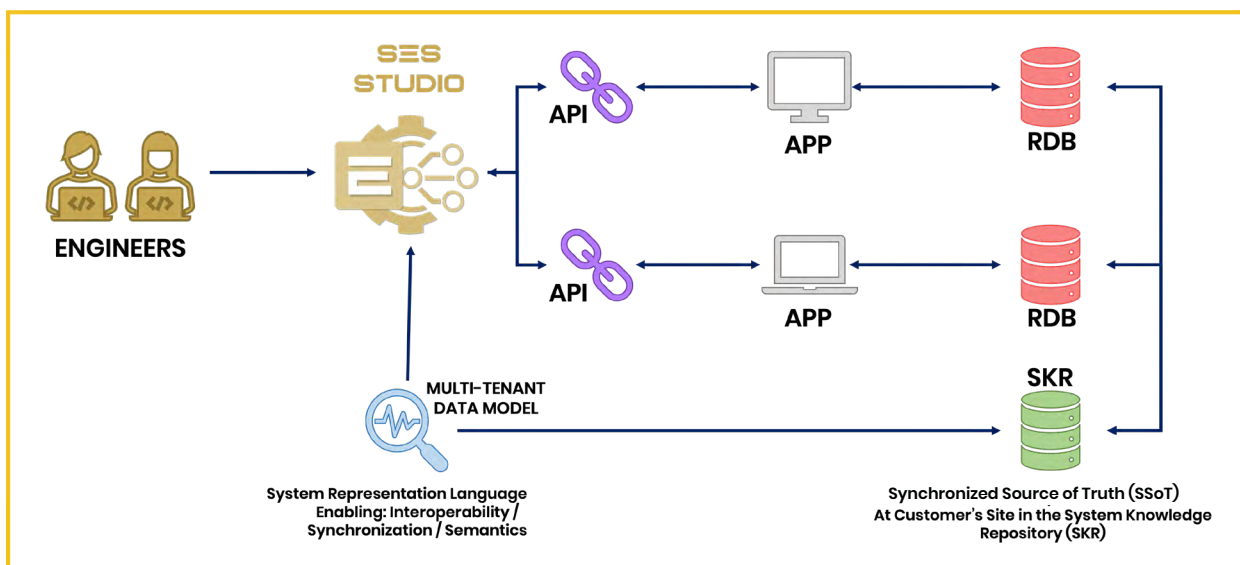

Traceability among all the connected sources

“Traceability plays an essential role to enable the digitalization of System Life Cycle management processes”

According to many standards and best practices, end-to-end traceability is fully required to properly succeed when defining, building, operating, and maintaining a system. Traceability is a key aspect of any engineering project. It prevents scope creep, and it plays an essential role when it comes to enabling the **digitalization of life cycle processes** as is aimed by the approach presented in this document.

Proper traceability among requirements is a must in every single project, it does not matter if the project is small or large. The support of traceability enables the typical RTM (Requirements Traceability Matrix) or even the RVTM, where an explicit link from each requirement is established to the tests (verification methods) that verify whether the system meets this specific requirement.

However, complex projects require more advanced capabilities, and not only for requirements. Traceability starts with the high-level needs, and even before that, with any of the so-called *life cycle concepts, which includes stakeholders, operational modes and scenarios, risks, constraints... and even regulatory bodies*. In the lower part of the approach, we can find conceptual modeling, physical modeling, and even source code, considering that modern smart systems now have more and more software within them. So, traceability

must be supported beyond the notion of requirements and tests: other systems engineering concepts shall be also traced (high-level goals, risks, use cases, SW, FMEA, the SOI, BOM (Bill of Materials), etc...).

The proper **digitalization of the life cycle** requires that any of the aforementioned items is explicitly linked to its origin. This complies with established industry standards and best practices such as ARP4754, DO-178/254, ISO15288, ISO26262, CMMI... Considering the demands from those standards, the different levels to be traced, the different nature of the items to be traced, the fact that each one of these types of items is normally managed within a different tool (Requirements Management Systems (RMS), modeling tools of all sorts, spreadsheets, common purpose word processors or PDF...), the recursion that characterizes the requirements engineering discipline, and the need for different “directions” of traces (forward, backward, as well as horizontal), it's clear that a spreadsheet will not be enough for this endeavor.

▶ **Following the recommendations from the standards, a tool to digitalize the life cycle shall meet, at least, these demands:**

- It shall **connect items from different tools**, regardless of the manufacturer, the types of items managed, and the actual server where they are stored... That's why an integration hub is a must, **avoiding one-to-one connectors/gateways**,
- it shall properly **react to changes in the sources**. To cope with this problem, SES implements the notion of **Synchronized Source of Truth**.
- Changes shall trigger the corresponding actions for **impact analysis**,
- **traceability matrices** to show all these connections in a user-friendly way.

▶ **However, let's focus on the productivity of the systems engineers, so about adding a set of nice and useful additional capabilities to the previous demands?**

- Establish traces among items without the need to open the source tools/repositories where those items are stored,
- **semantic traceability** to decompose a textual item (e.g., a requirement) and automatically identify the individual items that form it (is an actor or a state/mode named in the condition? Is a system element named in the subject of the requirement? Etc.). This also enables a **smart analysis of suspicious links**, where the engineer is only warned where a change is a meaningful change, avoiding alerts just triggered by minor changes in the description or any other meaningless block of an item,
- **automatic generation of traces** based on the actual meaning of your traceable items (model elements, textual requirements, risks, etc.); that is, traces suggested by the tool using different semantic and AI-based algorithms, waiting for the approval of the engineer to be stored as actual traces,
- complex reports and traceability matrices created with a click of a button,
- complete **baselining** and **configuration management** of all the items and traces, from one single point,

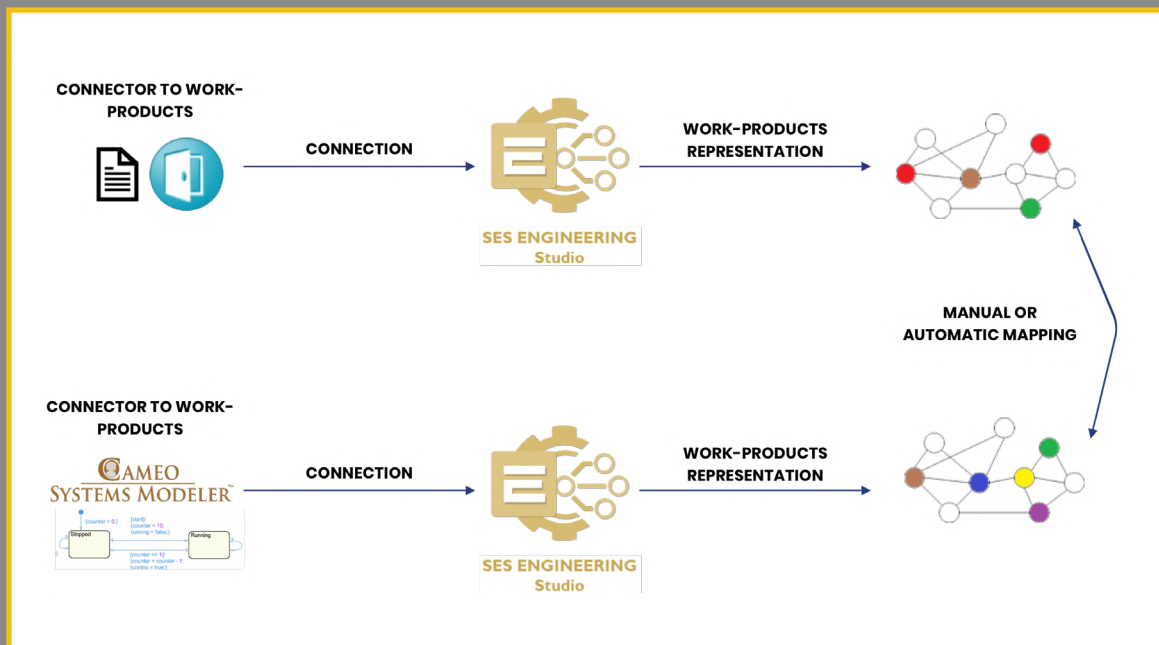

Interoperability inside the SES environment

With such an extended catalog of potential connections and the Synchronized source of Truth implemented, SES offers the capabilities required to interoperate between the siloed tools by offering basic and highly advanced functionalities. Among the elemental capabilities, referred to as **Operations**, the user could push information from a source to a target directly, smartly merge both sides, save automatically, and keep a complete *roundtrip* exchange among different tools and formats.

Regarding the advanced capabilities, referred to as **Transformations**, SES is capable of automatically converting information from one source type

to another. For instance, from textual elements to SysML models, from Arcadia models to SysML models, and vice versa, from Simulink to MS Visio, from textual requirements into test cases, automatic re-writing of low-quality requirements into high-quality ones, etc.

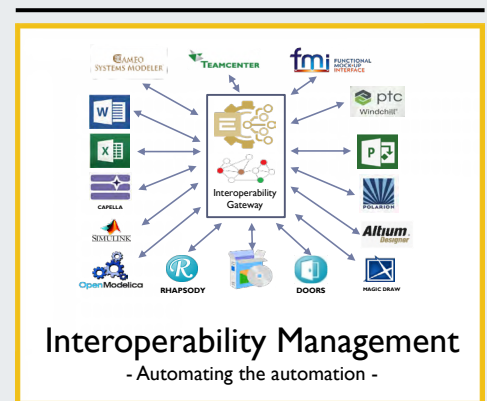

On top of the aforementioned options, systems engineers are granted the possibility to design and implement **Custom** interoperability activities, precisely suited and tailored to the specific needs of each project.

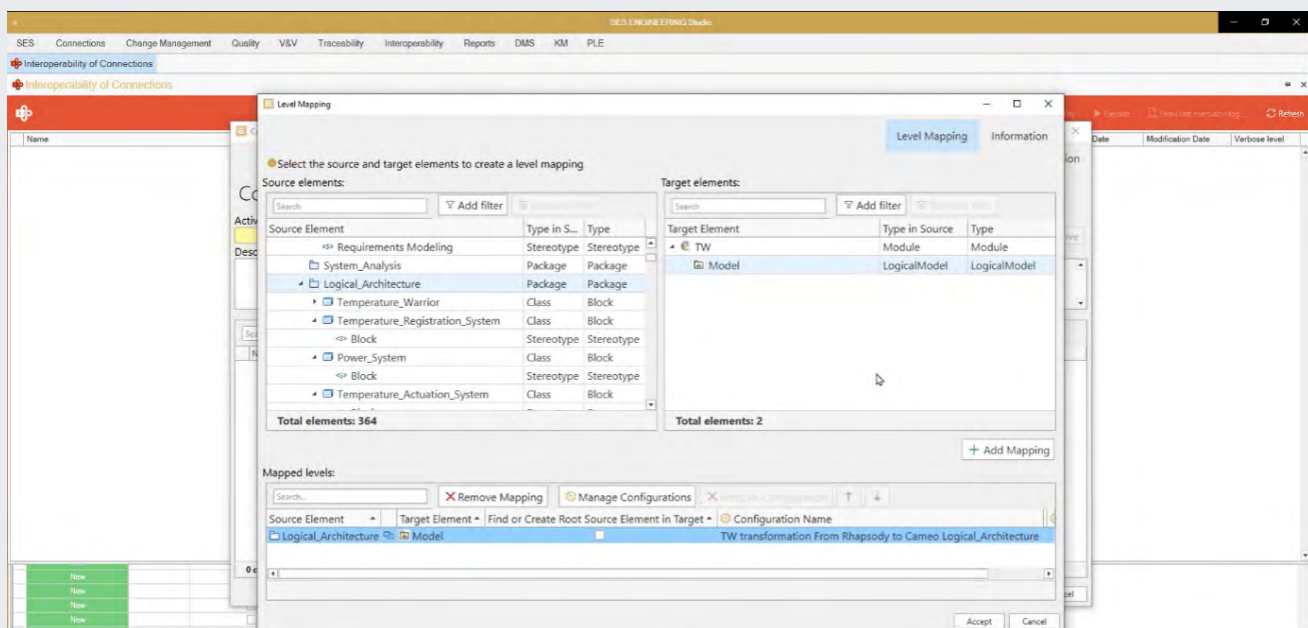

Technical Management Digitalization

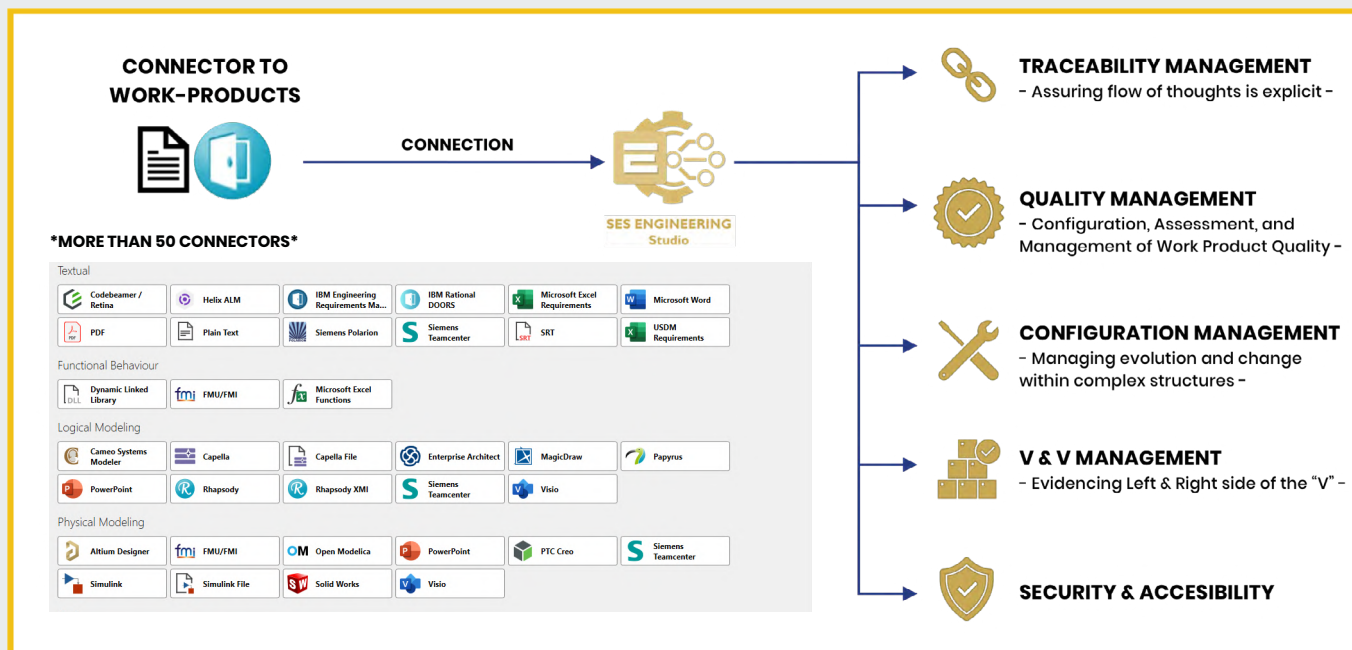

The ISO/IEC/IEEE 15288 standard defines the Technical Management processes as follows:

... are used to establish and evolve plans, to execute the plans, to assess actual achievement and progress against the plans, and to control execution through to fulfillment. Individual Technical Management Processes may be invoked at any time in the life cycle and at any level...

“SES provides full support to ALL technical management processes for EVERY connection”

With this context, SES has been designed to provide full support to all technical management processes defined in the 15288 standard for ALL connections.

Simplifying: when a new tool is connected to our Interoperability HUB, SES will automatically provide digital support to all the technical management processes (Quality Assurance and Management, Risk Management, Decision Management, Traceability Management, Configuration Management) and even more: Verification and Validation Management. Let us get deeper inside some of them.

Quality Management

The INCOSE Systems Engineering Handbook defines the purpose of the Quality Management process as to “assure that products, services, and implementations of the quality management process meet organizational and project quality objectives and achieve customer satisfaction”.

Since the SES ENGINEERING Studio's approach is to digitalize Systems Engineering activities across the system life cycle, the engineering items that need to meet the quality objectives are of any kind, which enables us to speak about *work-products* for describing requirements, model elements, test cases, risks, system elements, the system itself, etc.

The Quality Assurance and Management Capabilities of SES ENGINEERING Studio enable users to define quality configurations that will be applied to various work products throughout the development of the system. A quality configuration is made of metrics that check the *Correctness, Consistency and Completeness (CCC)* of the work products.

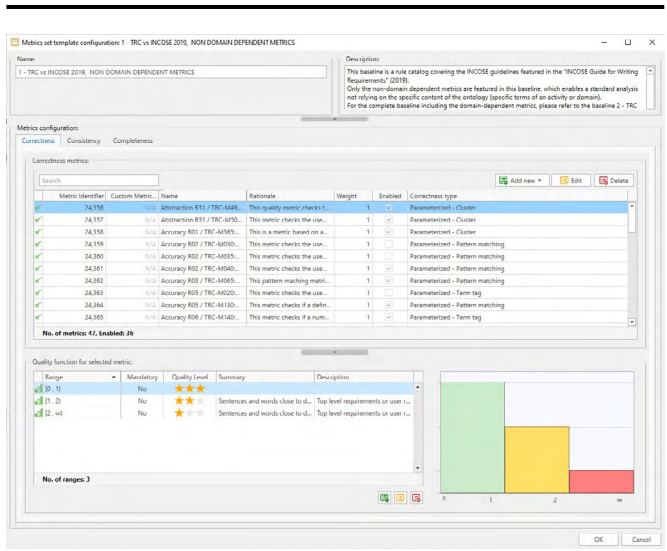

The CCC approach enables tackling an extended set of work products (requirements, models, SOI, ...) quality characteristics, going beyond a simple syntax check or keyword spotting. Starting from the standard

quality metrics template which implements a broad range of the quality rules set by the INCOSE in the *INCOSE Guide to Writing Requirements*, SES users can customize the configuration and create different baselines with new metrics to tailor the standard set to their internal procedures and domain-specific standards.

After selecting the configuration for a specific set of work products, users can run a quality assessment, which will consist of an automated verification, powered by the Natural Language Processing (NLP) engine and the AI-based semantic intelligence of the toolset.

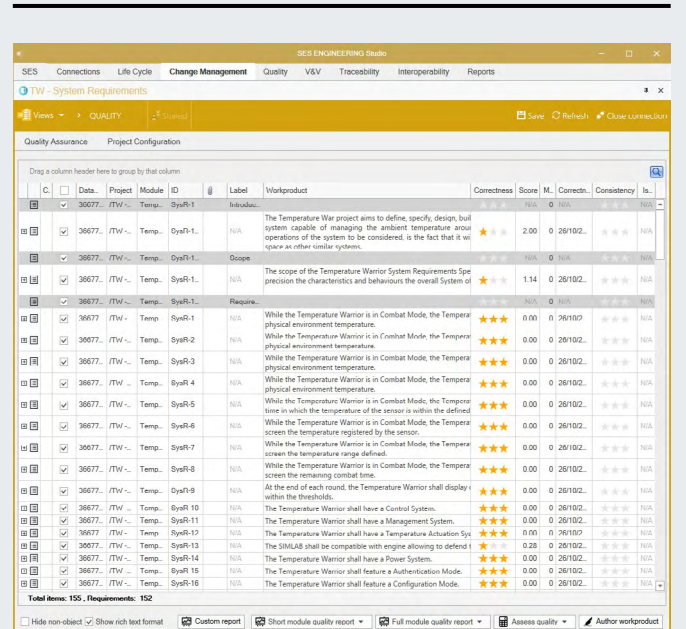

With the obtained results, the quality analysts can focus their effort and prioritize the review of the work products, starting with the ones that are rated as ‘Low Quality’ work products in the assessment. The work-product quality rating consists of three levels: ‘High’, ‘Medium’ and ‘Low’, which is calculated using a weighted average considering the metrics assigned by the user to the set of work products. The SES ENGINEERING Studio’s Quality Management Capability also offers options to monitor the evolution of quality between versions and to generate quality reports which will help the work-product authors manage how the quality is evolving over time.

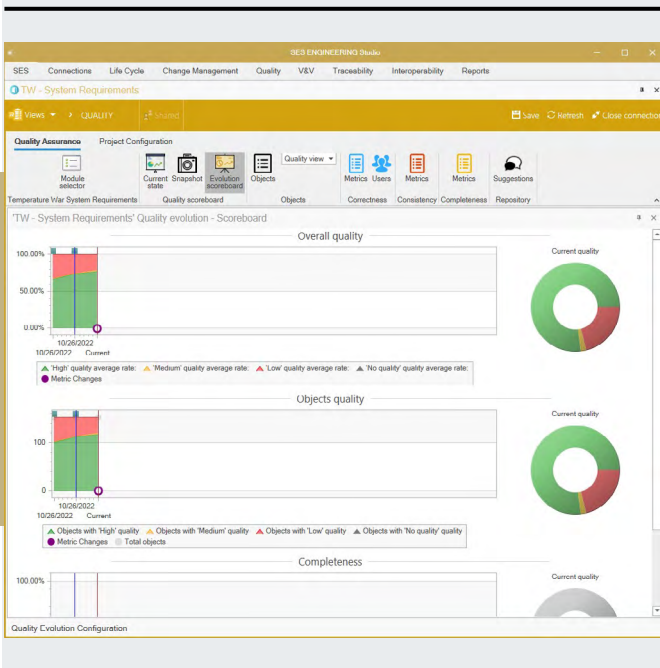

▶ Important summary:

The connectivity capability provided by SES allows applying quality assurance and management to whatever work product is used in the system life cycle (Requirements, model elements, physical designs, electronic models, manuals, BOM, etc.)

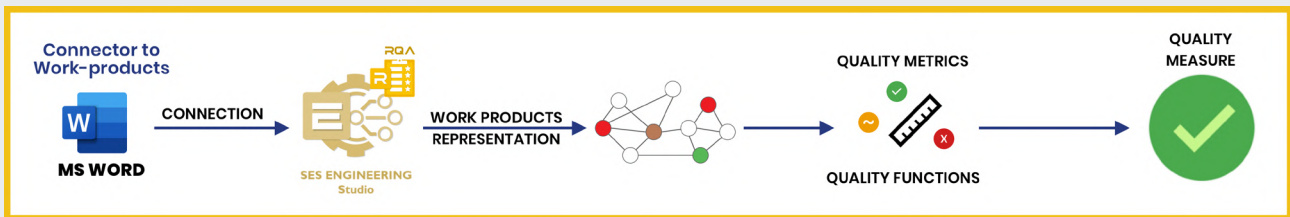

Verification & Validation

As an essential part of Life Cycle Management processes, the SES ENGINEERING Studio provides systems engineers with the environment, not only to digitally allocate the information and resources related to the verification or validation processes, but also to automatically execute certain assessments and store the verification or validation evidence in several different ways.

When enabled, the V&V Management Capability allows systems engineers to fully tailor any V&V process under the ISO/IEC 15288 and apply those to every single element extracted from the vast catalog of connectors to different sources. This is possible with the concept of Verification or Validation Action (VA). A VA is designed to allocate every piece of information related to the verification or validation process (technique, activities to perform, state, expected & obtained evidence, etc.).

In addition to this, certain V&V processes can be automatically assessed. By providing the expected and obtained evidences, the SES ENGINEERING Studio can apply a wide range of methods, including NLP, to compare both and suggest a potential outcome for the V&V process. It will, then, be up to the systems engineer to approve or deny this suggested state.

With the V&V processes executed, the V&V Management Capabilities include several reporting functionalities. Internally, the systems engineers will be able to access the Cur-

rent State section to visualize the current frozen image of the V&V state of the project. By taking several screenshots throughout the development, they will also have access to the Evolution Scoreboard, where this progress will be reflected. These two views are also included and amplified within the Dashboard section, along with overall summaries in terms of certain criteria and PBS level. Finally, the Browser option will provide an overall view of each specific element and its consequent V&V state, not only within the current connection but through all project connections.

These graphical representations can be included in automatically generated reporting documents with the possibility to tailor/customize the contents to be exported.

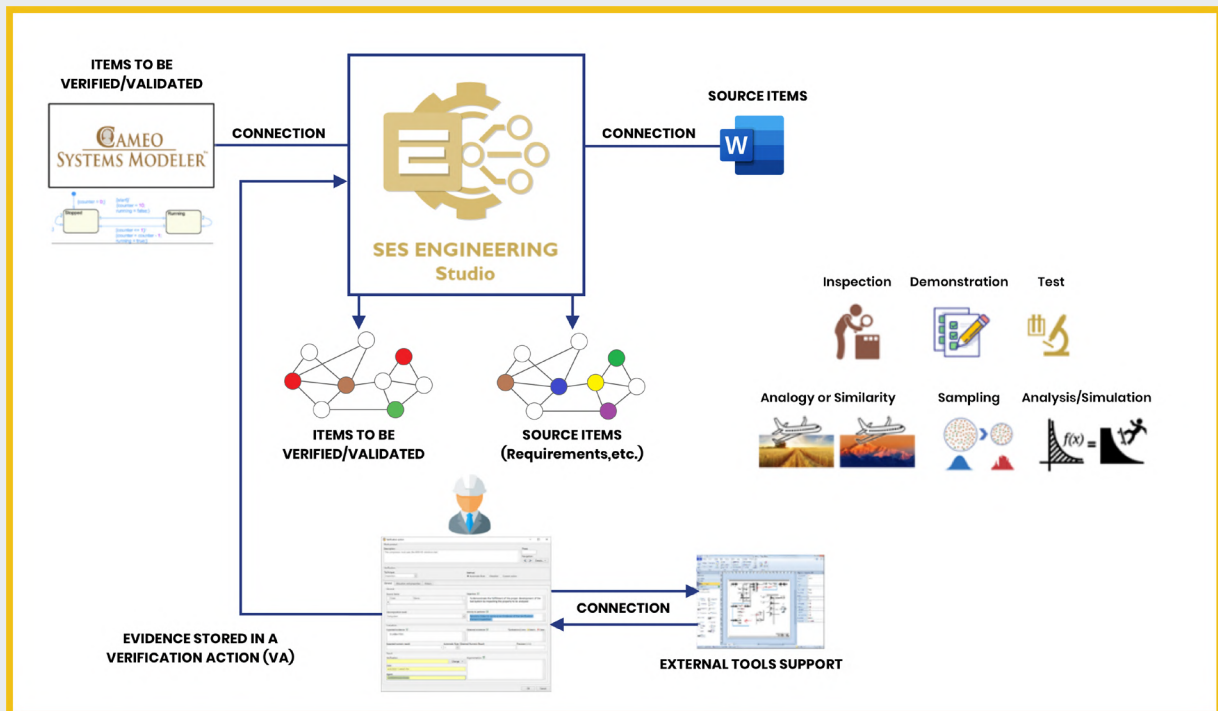

The typical Prepare for, Perform, and Results Management for Verification/Validation as stated in the ISO-15288 is fully implemented in SES ENGINEERING Studio.

Configuration Management (CM)

Some siloed tools provide configuration management, but others do not. When an engineering department uses SES, every connected tool is offered configuration management as it is perceived by The REUSE Company.

What is covered in our vision of CM?

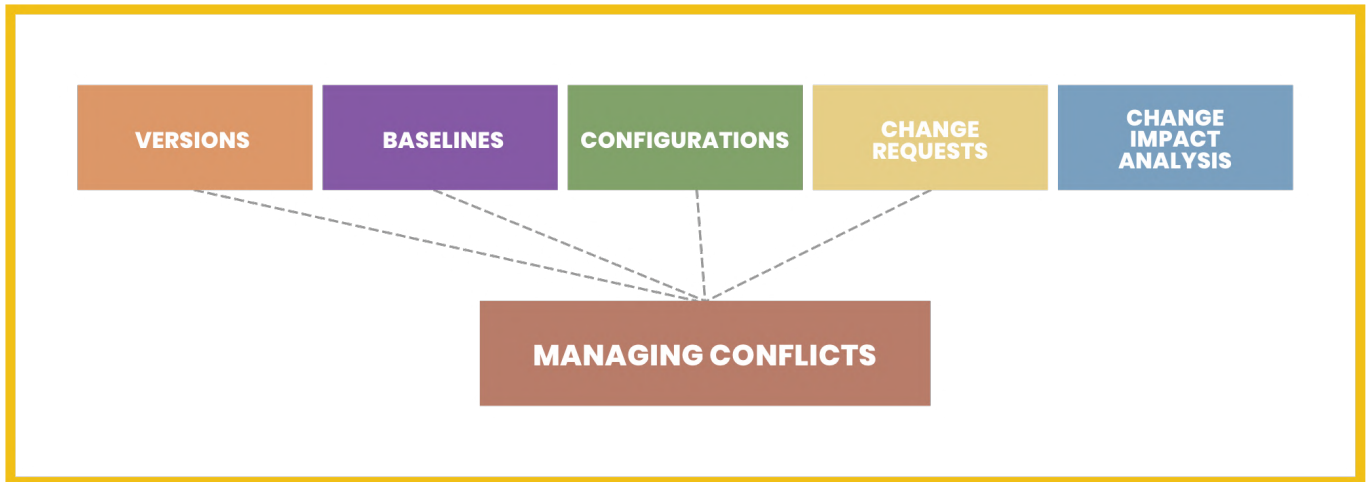

CM in SES ENGINEERING Studio covers Versions of individual work products, baselines of connections and configurations of projects. Besides, a change management activity is tailored to the specific authoring context (using external and independent tools to work with the different processes). A Change impact capability, where changes and

traceability are linked together, is also supported. Finally, a sophisticated conflicts management module, also based on the notion of users working from SES or directly in the source tools is offered to any granted user connected to the *Hub*.

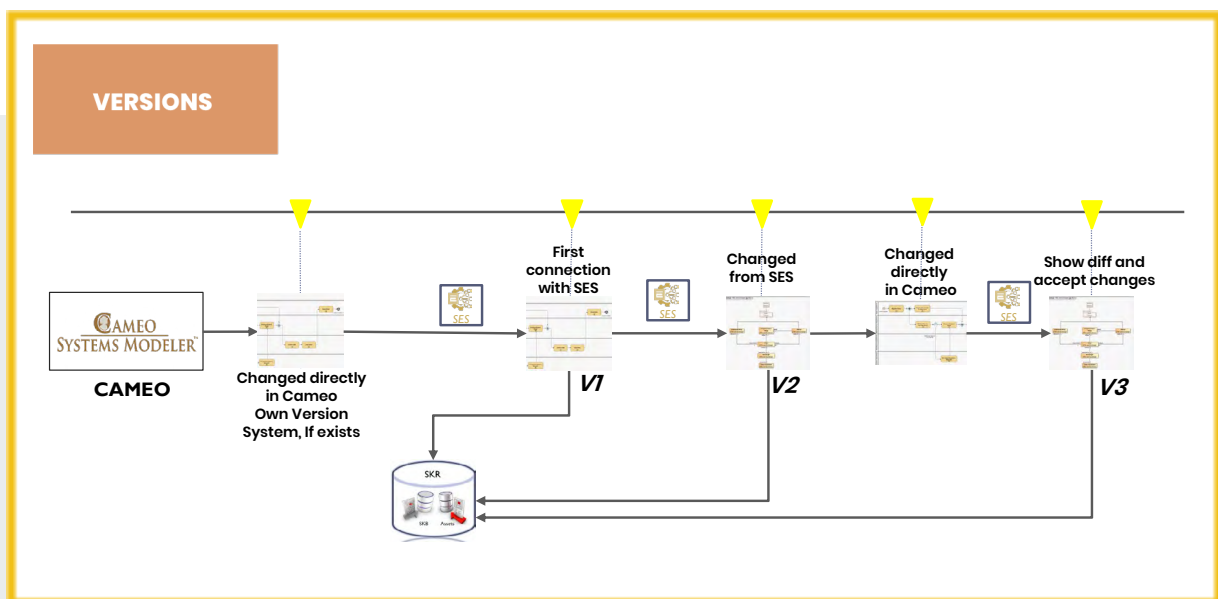

CHANGE REQUESTS

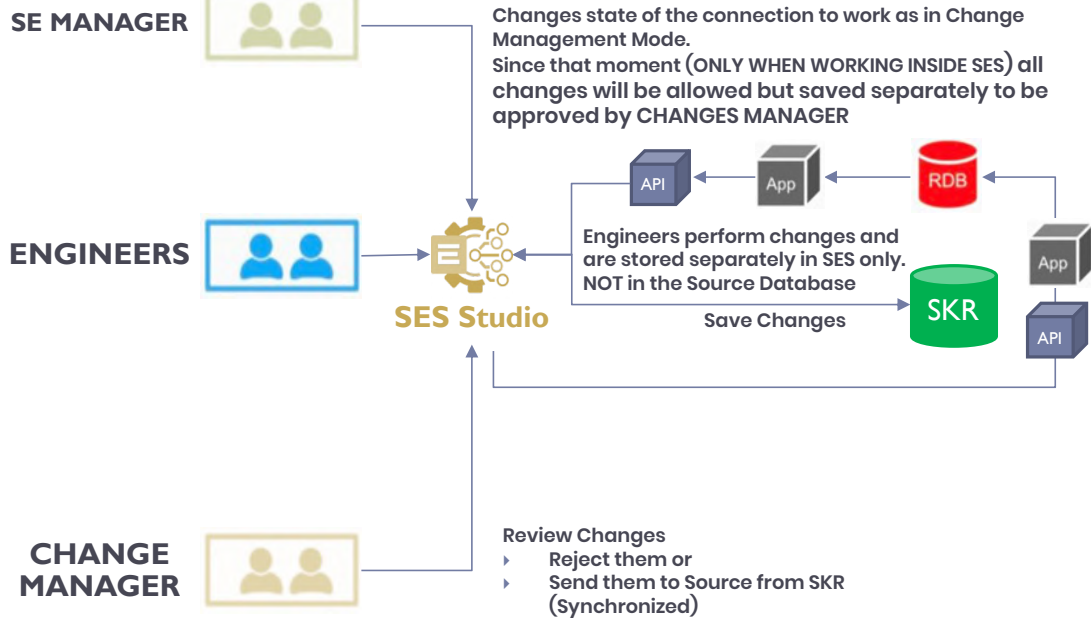

CONFIGURATIONS

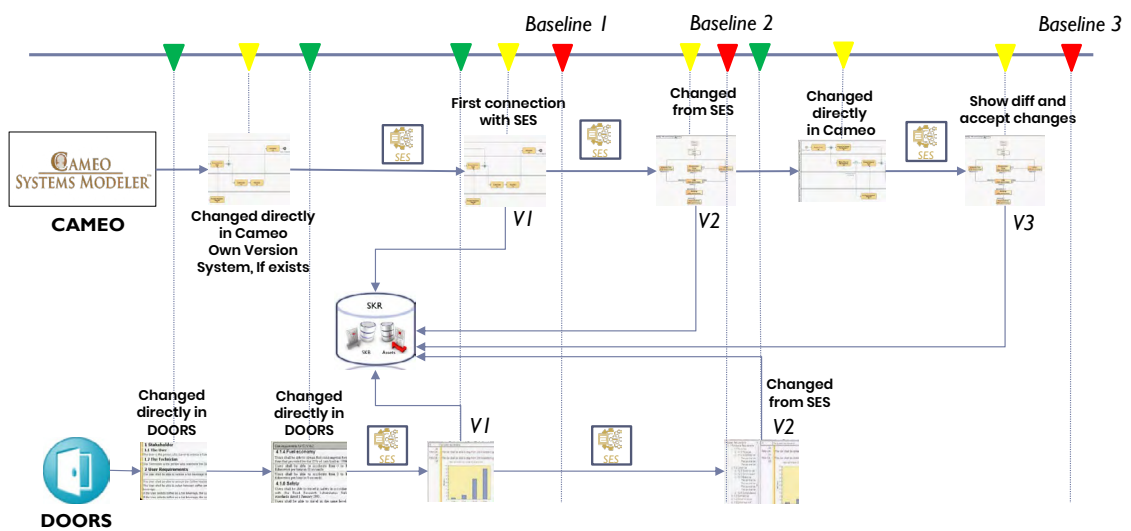

Increasing Productivity for Systems Engineers: SE Reuse

Produce *better*, with *less effort*, and *improve quality*

Nowadays, systems are getting more and more complex (and complicated), with more interactions, more capabilities...and so occurs with the corresponding engineering and life cycle management.

This aspect guides the need for increased productivity among all types of engineers (including systems engineers) involved in the projects. The goal is simple; produce better, with less effort, and with better quality. The previously described Technical Management processes allow us to measure all these characteristics, but we all need the facilitator to enable an improvement in productivity. We, in The REUSE Company, offer you a solution: REUSE Technologies. Simply said: we want to provide tools and technologies to increase the chances of reusing knowledge and information of all sorts, experiences, work products, engineering items, skills, lessons learned... you name it.

The following technologies are available within the SES ENGINEERING Studio:



Work-products Reuse (available from V23.4 and above)

The integrated hub where information from different tools is centralized and synchronized can be seen by some stakeholders from an administrative standpoint as the “ground truth”. However, another of the benefits of this approach is the possibility of enabling **semantic search engines**. Every time an element is baselined, it is included in the repository through a process called **semantic indexing**. Later, when in need of past knowledge, engineers can always access the **semantic search engine** included in the SES integrated hub and proceed with the so-called *fine-grain reuse*, thus retrieving work products such as requirements, diagrams, risks, constraints, etc. searched by content. Even more, through the traces of those reused elements with other elements, engineers will increase their chances of reusing a “bigger” picture.



Product Line Engineering (PLE) (Available from V23.4 and above)

Another benefit of the smart indexing capability included in the SES Interoperability HUB is the support for product lines (**PLE – Product Line Engineering**). Following this approach, new products can be automatically instantiated (requirements documents, logical models...) just by selecting options in the feature model and providing the information for the variability points. Thus, the Interoperability HUB can connect to the engineering tools to produce new work products inside the selected engineering tool (RMS, MBSE tools, 3D tools etc.). Furthermore, through the semantic capabilities of the hub, the Feature Models and their variants can be automatically generated just by comparing the information from different legacy and previous projects aiming at representing similar Systems of Interest.



Enabling products Reuse

The SES Interoperability HUB enables shared connectors to blocks of information (requirements, architectures...) ready to be reused in your new projects. Links from the actual reused elements and the original elements will be established automatically so that, when a reusable item needs a change, a quick impact report is generated. The SES Interoperability HUB is not only the home of engineering items, but it can also be the store of **enabling assets** (aka organizational process assets). Templates for different types of documents, templates for reports, catalogs of rules for the creation/authoring of work products (quality rules for requirements, coding rules for source code...), design patterns for architecture and modeling, patterns for textual artifacts (e.g. requirements, etc.). All of this is also part of the hub and can be evolved and applied over and over in the different projects connected to the same hub.



Technical Management Reuse

Some engineers might consider technical management processes as “undesired” and that the work to be done for implementing them is a “must be done even if I really would not like to spend time on them”. Therefore, enabling reusability of these activities, as is implemented in the Systems Engineering Suite, will reduce the time to be spent on them.

In this context, activities such as the automatic verification of work products based on quality metrics (at both sides of the “V-Model”), the automatic suggestion of traces, the automatic generation of feature and variability models, automatic comparison of differences at any level, automatic reuse of quality policies etc. will impact the productivity of engineers.



Knowledge Reuse

All the reuse activities described so far are based on the concept of a **knowledge base**. In the approach followed by The REUSE Company, a knowledge base is a special kind of ontology, including not only the knowledge related to a specific business domain (layers #1 and #2 of the ontology), but also the semantic information of the different assets represented in the hub (the SAS - System Asset Store). Layers #3 and #4 represent the patterns and the formalization of the patterns that enable the automatic extraction of structured information (relationships and metadata) out of textual artifacts. Finally, layer #5 represents the smart actions and operations (reasoning based on semantic approach and Artificial Intelligence) leveraged by this knowledge base (semantic indexing and retrieval, automatic quality checking, suggestion of traces, classification of requirements, automatic extraction of vocabulary...).

01 Vocabulary

Controlled Organizational and Project Vocabulary for a common understanding among stakeholders



02 SCM/Architectures

Recreate and capture the system architectures represented in views and models. Establish relationships among system and system elements

05 Reasoning

A combination of rules, tasks and groups to infer information from valuable assets

04 Formalization

Representation of assets semantic through SRL – System Representation Language

03 Patterns

Represent requirements similarities and enable formal representation, automatic recognition and aid authors



Smart Authoring: Reuse kills the “blank page” syndrome

For many engineers, facing a blank page is usually not comfortable. It always demands an additional kick of effort to defeat this situation. Our Interoperability HUB has the choice to facilitate a solution. Combining the knowledge base, the repository, the smart indexing, and artificial intelligence, it is possible to produce smart authoring tools enabling the automatic generation of engineering items based on the information from previously created work products.

Would you like to write requirements guided by tools offering you terminology suggestions, assuring the quality of the texts while typing, guiding you with the best requirement structure, and connecting and tracing the model elements with the requirements when writing them? Yes? Then just check out our **AUTHORING Tools**.

Digitalizing System Life Cycle Management (SysLCM) processes

In engineering we use the concept of a life cycle to describe the complete life of an instance of a system-of-interest (SOI), and the managed combination of multiple such instances to provide capabilities that deliver stakeholder satisfaction.

A life cycle model identifies the major stages that a specific SOI goes through, from its inception to its retirement. Life cycle models are generally implemented in development projects and are strongly aligned with management planning and decision-making. These stages are then stated in a workflow for their management. The Technical and Technical Management processes are mostly devoted to accomplishing the work in every stage.

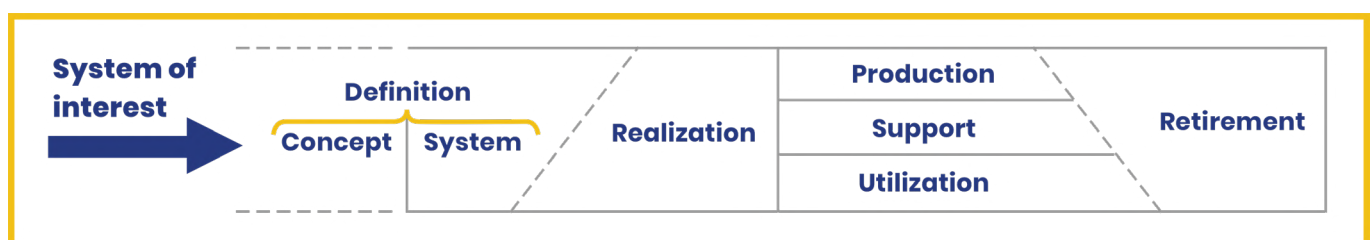

Project digitalization

Systems Engineering technical and management activities are defined in a set of life cycle processes according to standards like ISO15288.

The need to connect to different information assets (supported by engineering tools) and synchronizing the master information for the different life cycle steps has already been mentioned as an important capability. This functionality gets even more important when the concept of life cycle management becomes relevant. To digitalize SOI project, the corresponding activities must be “work-flowed” to allow the information to “flow” in the right order.

To cope with this need, the SES Interoperability HUB, in its version V23.4 and above, enables systems engineers to define a workflow of information sources (a workflow of engineering tools), making possible a seamless flow of reusable information where experts can apply their different capabilities to manage and transform this information.

Simplifying:

You can define your life cycle workflow, and determine which engineering tools are you going to use in every process, and SES will help you with the digitalization and management of the workflow. To manage the life cycle workflow, SES allows to control and analyze the progress of every technical process activity by providing technical management KPIs (information Correctness, Consistency, Completeness, Verification and/or Validation Completeness, Traceability Consistency and Completeness, etc.)

Using life cycle templates – The REUSE workflow

These closely-grouped-together related activities allow us to describe the relationships between processes and the corresponding information. There are several views on the nature of the inter-relationships between process activities within a life cycle model as well as there are different aspects connected to the business domain, development model or type of system that affects both the content and steps to consider when defining an appropriate project plan.

Simplifying:

To organize a SOI development project, different life cycles can be applied, and one of them must be selected. SES allows us to define life cycle templates, and instantiate them for new system projects.

Extending Microsoft Word: Requirements Engineering and SES

The development of complex safety-critical systems is controlled by many different standards. Most of them reference Requirements Management as a must. Requirements Management can be defined in many ways. In ISO/IEC 29148 it is defined as:

“Requirements management encompasses those tasks that record and maintain the evolving requirements and associated context and historical information from the requirements engineering activities. Requirements management also establishes procedures for defining, controlling and publishing the baseline requirements for all levels of the system-of-interest.”

A few activities can be noticed:

Evolving – i.e. not static. Handling Change is a key task for Requirements Management.

Associated context and historical information – There is a lot more data than only requirements that need to be managed to maintain a correct, complete and consistent understanding of the Requirements statements. Requirements Management must manage this information as well, over time and across organizational boundaries.

Controlling and publishing – The implication of them is that Requirements Management must take command over information status to be able to respond to the question “what is included in each baseline?”

All levels of the system-of-interest – A multi-level specification structure, including links, must be maintained.

As the definition states, the management of requirements must be included in a wider discipline, Requirements Engineering (RE). This discipline intends to cope with requirements within its entire life cycle.

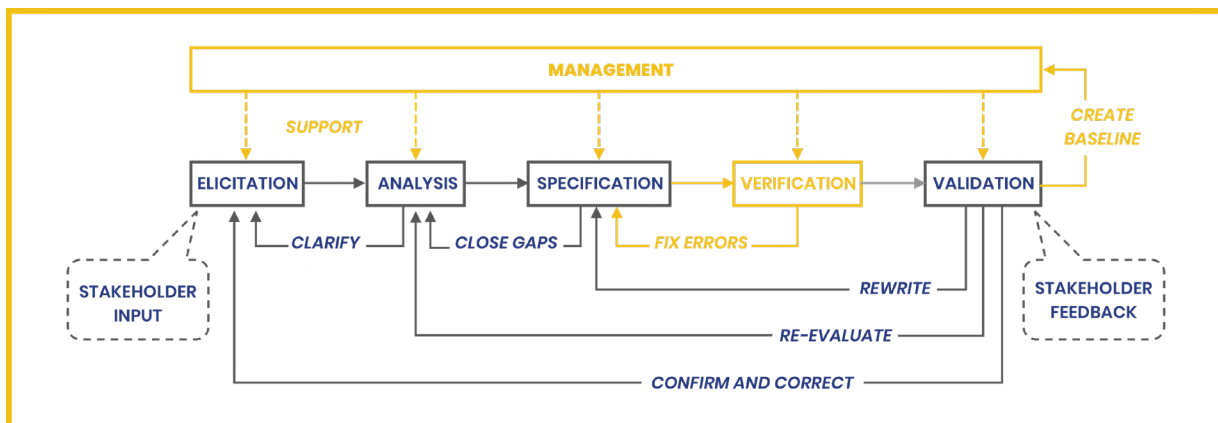

Inspired by Karl Weigers

Within the Systems Engineering community there is a mature consensus on the different stages shaping the requirements engineering life cycle. Every stage applies its own activities to cope with the different tasks assigned to it.

For example, the elicitation stage requires smart authoring (computers guiding humans in the writing process). The Analysis stage demands external means to support decisions (Artificial Intelligence), and the Specification Stage seeks automatic documentation procedures, modern text generation technologies etc.). The important Verification Stage needs automatic ways to provide Correctness, Consistency and Completeness (CCC) regarding the quality of the requirements. The Validation Stage uses digital tools to manage evidence of all sorts from stakeholders.

And finally, the management state must provide unlimited traceability to any engineering item in the system life cycle, powerful attributes management, strong configuration and versions management, change management, change impact and conflicts management.

Even if every mentioned activity demands specific computer tools, the requirements authoring, where requirements are written, is the core of this process. A good and rich text editor is a must within Requirements Engineering, and we in TRC consider Microsoft Word one of the most powerful rich text editors in the market. Almost everyone knows how it works and has a decent level of mastering it. It is a kind of legacy tool.

Although Microsoft Word is a superior editor, it lacks all the rest of the features to become a great Requirements Engineering (including Management) tool. Why not reuse the skills and the capabilities of Microsoft Word and implement inside it all the demanded features?

This has been the approach of The REUSE Company when we decided to implement SES Interoperability Hub inside Microsoft Word. The combination of both tools provides everything necessary to consider Word a great Requirements Engineering tool:

Requirements Engineering and SES:

- ▶ A rich and powerful text and graphs editor
- ▶ Support to Requirements Identification using smart text understanding technologies
- ▶ Creation and deletion of requirements, either within the document or in tabular mode
- ▶ Manage versions, baselines, and configurations for the requirements and the document.
- ▶ Manage change requests, change impact, and conflicts for multiuser editions
- ▶ Assess and manage the Quality of the requirements using the CCC paradigm
 - ▶ Correctness, Consistency, and Completeness
- ▶ Universal support to full traceability against whatever engineering tool in the System Life Cycle ecosystem. Requirements can be traced against models in MBSE tools, documents in PDF, 3D model parts, simulation functions, PLM objects, etc.
- ▶ A Smart Requirements Authoring plug-in, to write requirements complying the selected quality rules (for example the INCOSE rules) and based on requirements patterns (for example the EARS patterns)
- ▶ Interoperability of the requirements with MBSE or whatever other tools
 - ▶ Generation of models from the requirements
 - ▶ Generation of requirements from the models
 - ▶ Transformation from Arcadia to SysML models and vice versa
- ▶ Verification and Validation of the requirements
 - ▶ Digitalize the collection of evidence to support the Verification & Validation Actions as stated in ISO 15288

The SES ENGINEERING Studio Plug-in for Microsoft Word delivers all these capabilities and transforms the editor into a powerful Requirements Engineering tool.

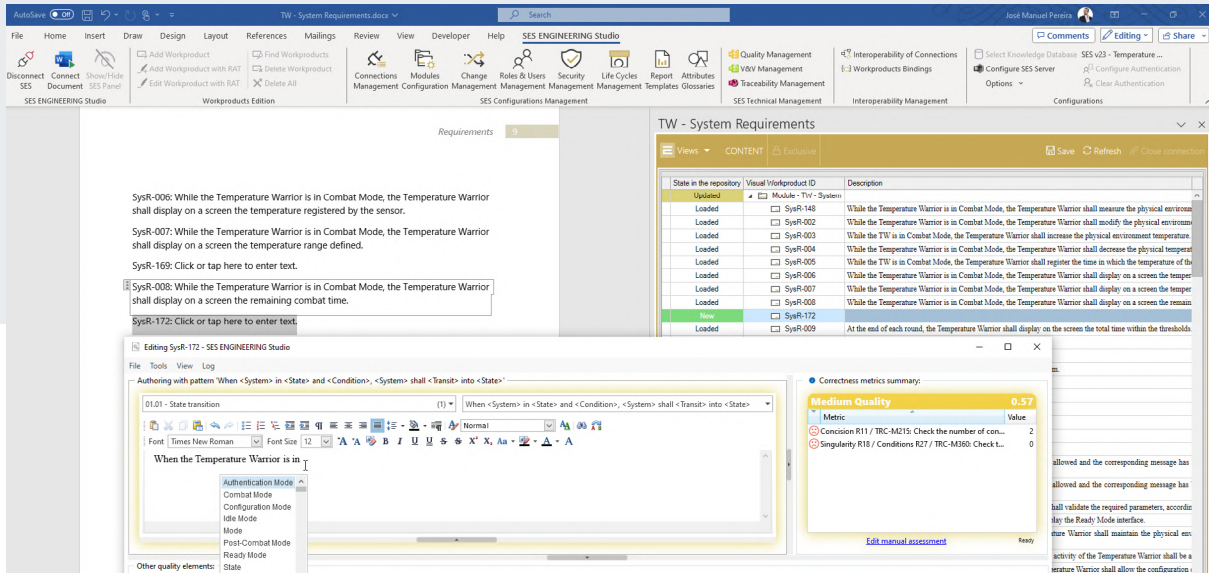

SES inside other Engineering tools

Aside from these add-ins, the Interoperability HUB developed by The REUSE Company also features other add-ins to be installed on top of your own engineering tools (IBM DOORS and DNG, PTC Windchill, Capella, Cameo, Rhapsody...). So, the capabilities described in this brochure, es-

pecially the implementation of the technical and technical management processes, are not just part of the SES ENGINEERING Studio, they can also be found seamlessly integrated on top of many well-known engineering tools.

CONCLUSION

Every human-made system has a life cycle, even if it is not formally defined.

The REUSE Company embraces the notion of System Life-cycle Management (SysLCM) as the conceptual mechanism to manage a System's life with the guidance of Systems Engineering.

The SES ENGINEERING Studio concept offered in this document intends to manage the System of interest life cycle by integrating and interoperating the complete ecosystem of tools involved in its design, production, operation, maintenance and retirement. In Addition, once being the Interoperability HUB, SES provides full technical management

support (CM, Traceability, Conflict mgmt., quality mgmt., Information mgmt., knowledge mgmt., etc.) to a wide list of connectable tools allowing smart interoperability among them. The combination of connectivity to existing tools, interoperability among them, technical management digitalization for whatever connection, ontologies, a repository for synchronizing the sources of truth, and the possibility to define life cycle models, provides a powerful system life cycle management solution with a strong REUSE approach.

Please, contact us if you'd like extended information.

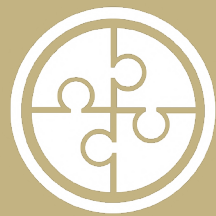

THE
REUSE
COMPANY



Contact Us



@ReuseCompany

Address

Margarita Salas, 16
Parque Tecnológico LEGATEC
28919 Leganés - Madrid, Spain

Contact

+34 912 17 2596
contact@reusecompany.com

Website

www.reusecompany.com